

KITCHEN

PRODUCT CATALOGUE

marmorin

MARMORIN is a B2B manufacturer of washbasins, bathtubs, shower trays and kitchen sinks. Based in European Union, the company specializes in private-label and custom design products made with advanced casting technologies and innovative materials. With over 35 years of experience and technological know-how, Marmorin is a reliable partner that supports Your business, brand and product.

















SUPPORT FOR YOUR BUSINESS, BRAND & PRODUCT

NOTICE! Availability of products may differ by region.

MAGRANIT®

CAST QUARTZ STONE

MAGRANIT® is our unique material solution engineered specially for production of casted kitchen sinks. The material is primary made of pure and natural quartz which makes it very strong and durable. The quartz aggregate is bounded together with dedicated resin and additional refining compounds creating material dedicated for kitchen environment. MAGRANIT® products have uniform void-free structure and are resistant to very high temperatures. Perfect surface finish ensures high level of hygiene and makes it easy to clean. Chemical and physical characteristics of MAGRANIT® allow for casting products of various shapes and sizes. From small and compact solutions to large sinks. In addition, the material comes with a wide range of color options, from cool to warm tones.

 UNIFORM STRUCTURE	 HIGH CONTENT OF NATURAL MINERAL	 ODOUR NEUTRAL	 WIDE COLOR PALLET	 SCRATCH-RESISTANT
 IMPACT-RESISTANT	 VOID-FREE AND NON-POROUS	 THERMAL-SHOCK RESISTANT	 SURFACE ABRASION RESISTANT	 STAIN-RESISTANT
 FULLY DEAERATED	 EASY TO CLEAN	 HYGIENIC	 SELF-EXTINGUISHING	 UV-RESISTANT

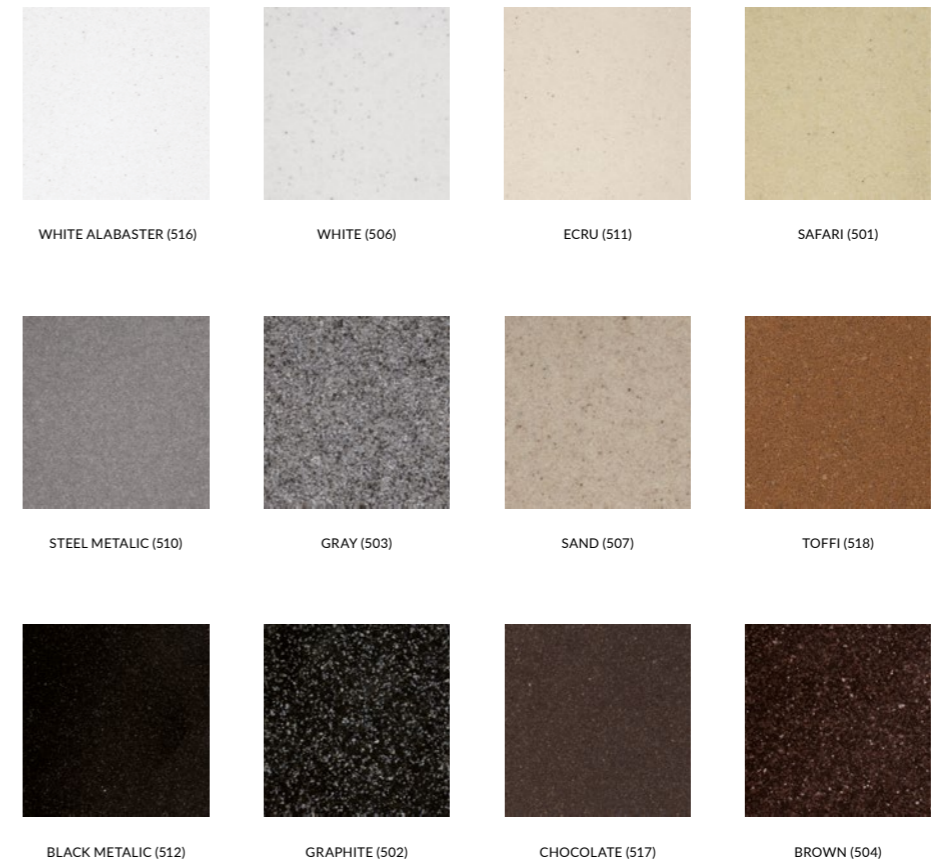

Due to limitations in the printing process, colors may vary.



PRODUCTS

MINIMAL CABINET SIZE

40 cm

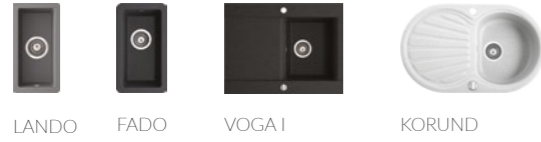

LANDO FADO VOGA I KORUND

45 cm

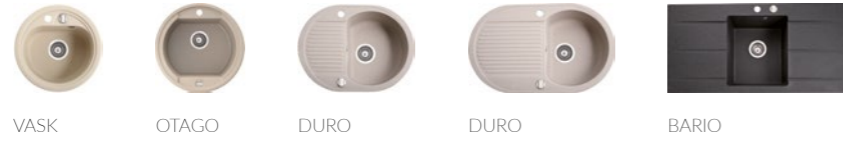

VASK OTAGO DURO DURO BARIO

50 cm



DURO TANAT KOVA LAVER FADO NERO IGNIS DATO
VOGA II OTAGO IGNIS TORRO CIRE DEBRA

60 cm



EWIT LANDO FADO FADO TONO TONO NERO
VOGA I VOGA I VOGA I TESSA CIRE CIRE
HALIT BARIO BARIO BARIO BARIO BARIO



FOORN II PROFIR IVO IVO TORRO IGNIS
OTAGO DURO KORUND LAVER LAVER

60 cm



FOORN I BATEA DEBRA VOGA II DEBRA

70 cm

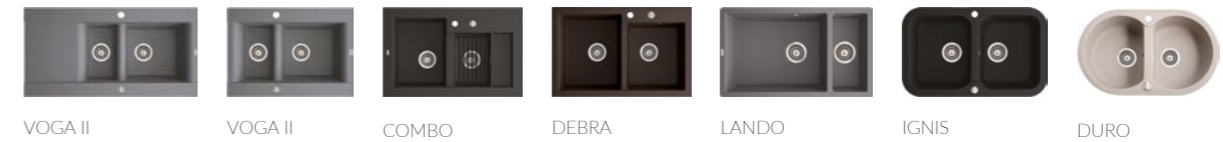

VOGA II VOGA II COMBO DEBRA LANDO IGNIS DURO

80 cm



PROFIR OPAL AKO AKO CIRE CIRE



PROFIR PROFIR OLWIN II OLWIN I EWIT EWIT RUBID

90 cm



DEBRA DEBRA + 80 DURO + 50 CIRE + 80 BARIO + 60 TORRO + 80

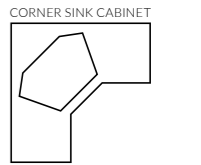

CORNER SINK CABINET

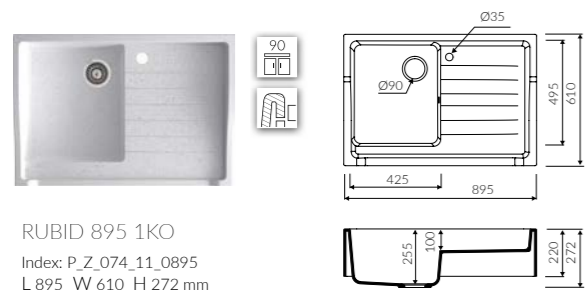

RUBID 895 1KO
Index: P_Z_074_11_0895
L 895 W 610 H 272 mm

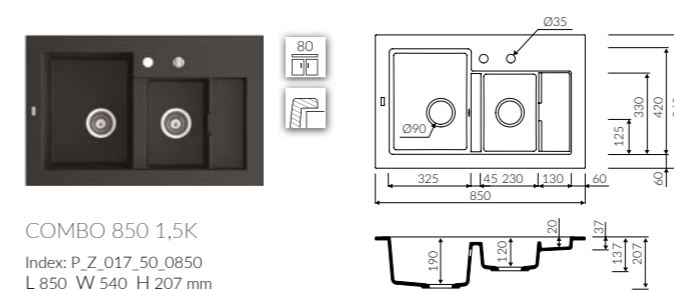

COMBO 850 1,5K
Index: P_Z_017_50_0850
L 850 W 540 H 207 mm

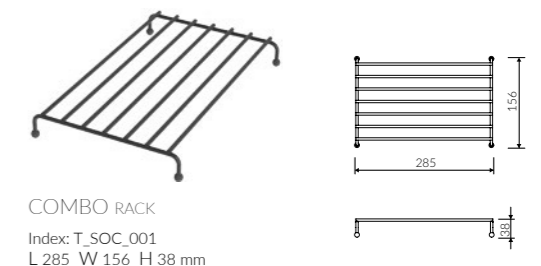

COMBO RACK
Index: T_SOC_001
L 285 W 156 H 38 mm

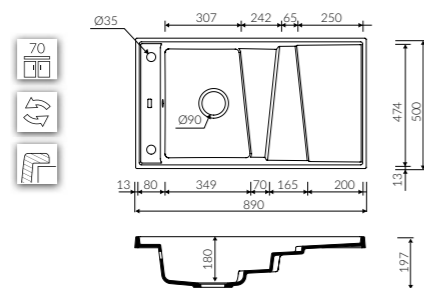

BATEA 890 1KO
Index: P_Z_011_11_0890
L 890 W 500 H 197 mm

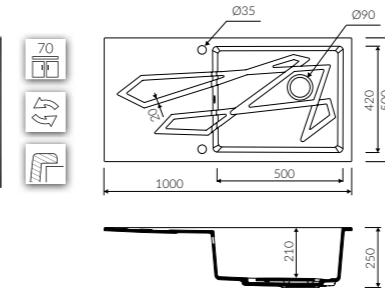

FOORN I 1000 1KO
Index: P_Z_034_11_1000
L 1000 W 500 H 250 mm

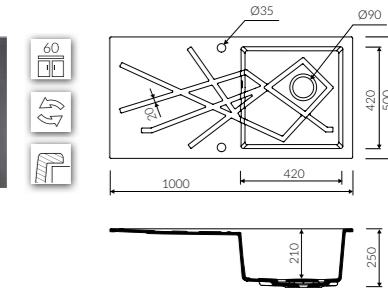

FOORN II 1000 1KO
Index: P_Z_034_11_1000
L 1000 W 500 H 250 mm

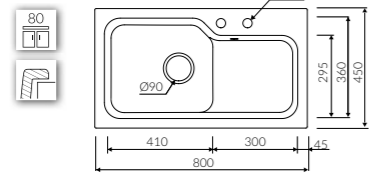

AKO 800 1KO
Index: P_Z_001_11_0800
L 800 W 450 H 207 mm

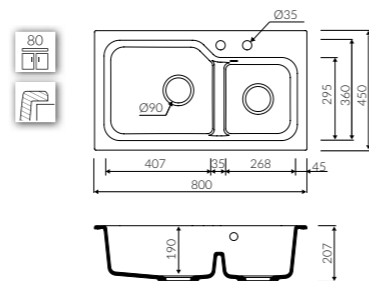

AKO 800 1,5K
Index: P_Z_001_50_0800
L 800 W 450 H 207 mm

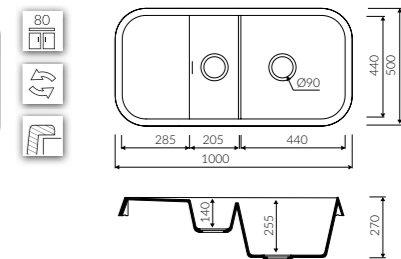

OPAL 1000 1,5KO
Index: P_Z_064_51_1000
L 1000 W 500 H 270 mm

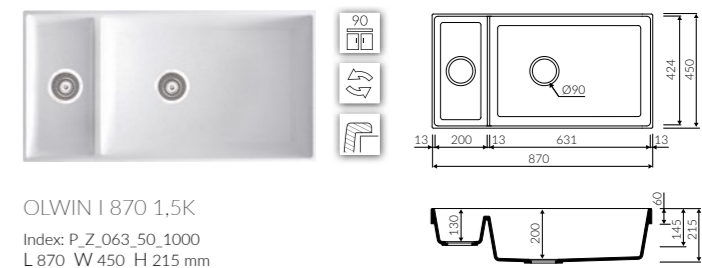
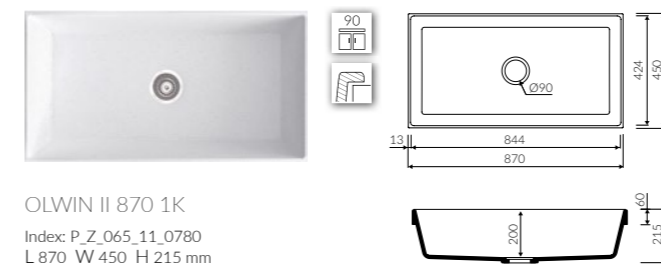
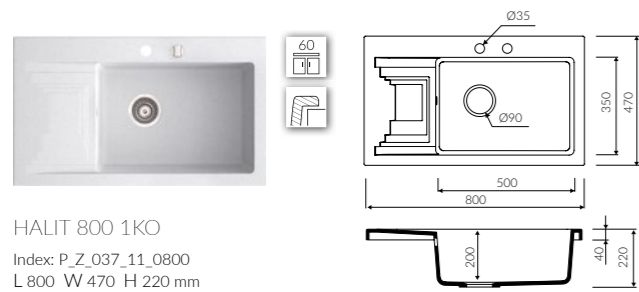

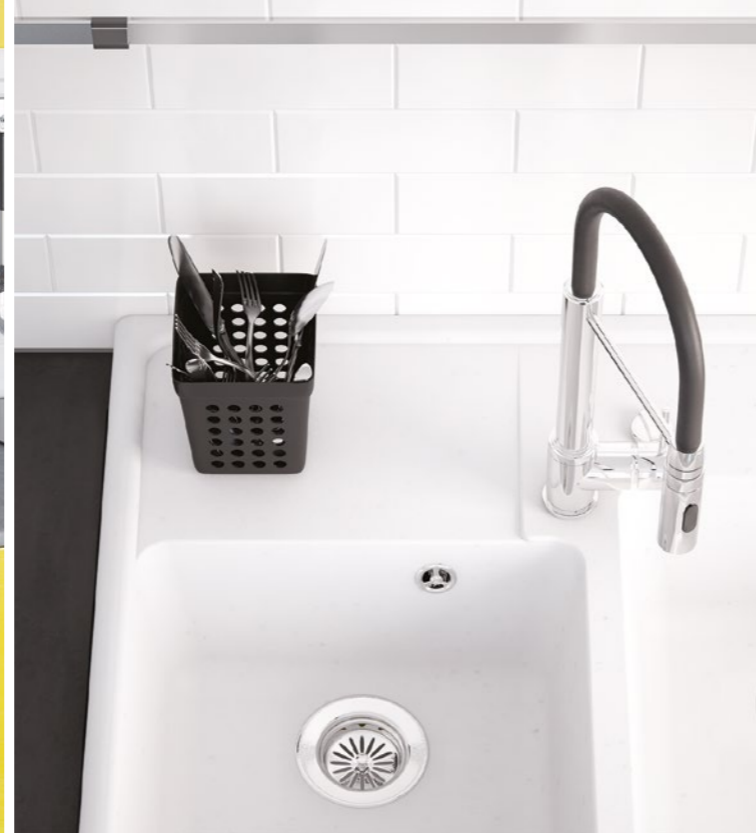

EWIT 595 1K
 Index: P_Z_029_10_0595
 L 595 W 630 H 210 mm

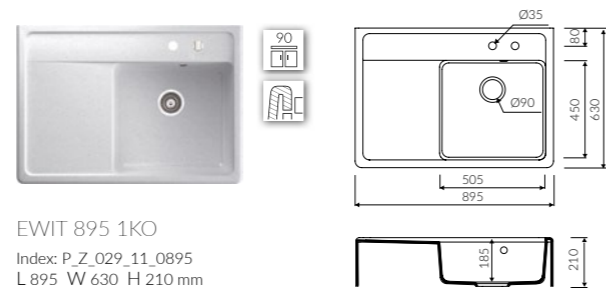

EWIT 895 1KO
 Index: P_Z_029_11_0895
 L 895 W 630 H 210 mm

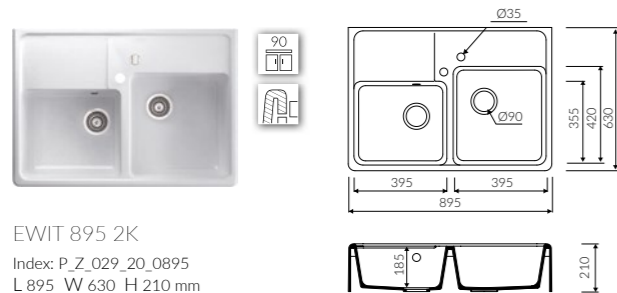

EWIT 895 2K
 Index: P_Z_029_20_0895
 L 895 W 630 H 210 mm

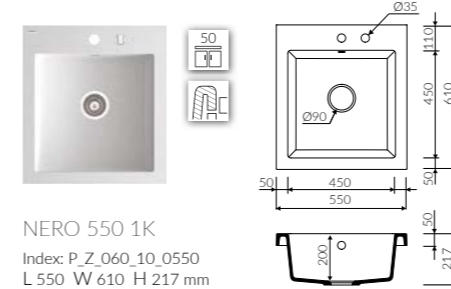

NERO 550 1K
 Index: P_Z_060_10_0550
 L 550 W 610 H 217 mm

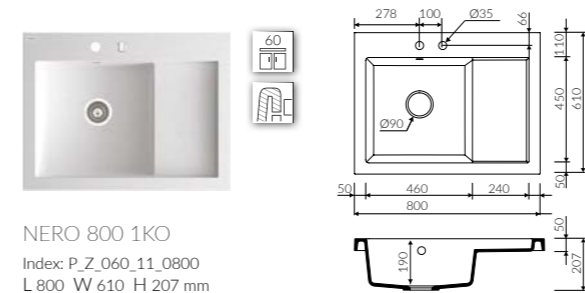

NERO 800 1KO
 Index: P_Z_060_11_0800
 L 800 W 610 H 207 mm



NERO 550 CUTTING BOARD
 Index: T_SDE_004
 L 544 W 266 H 30 mm



NERO 800 CUTTING BOARD
 Index: T_SDE_003
 L 434 W 240 H 41 mm



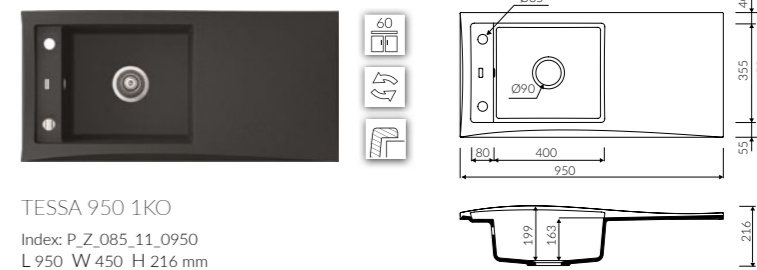
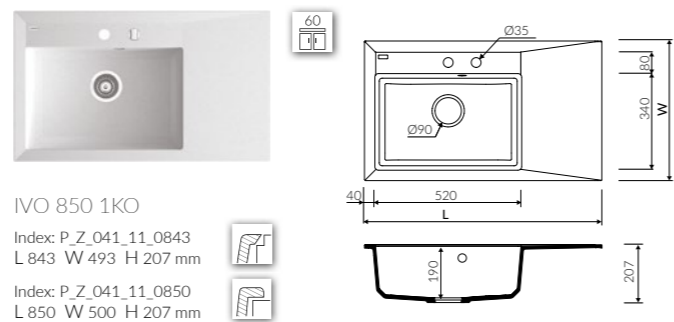
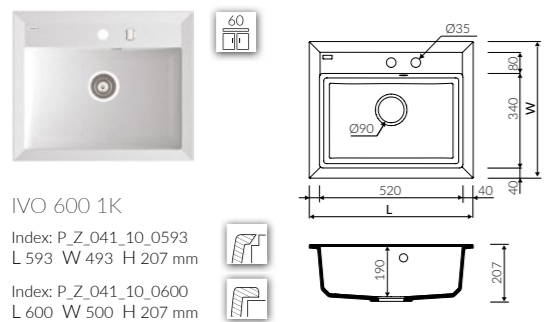

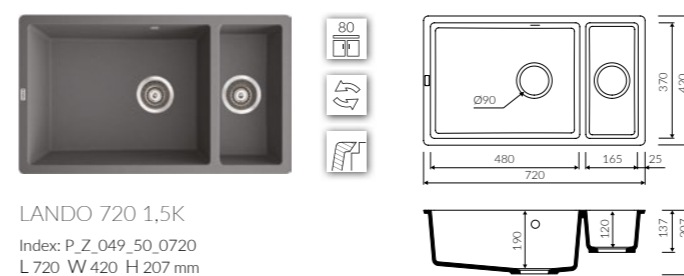
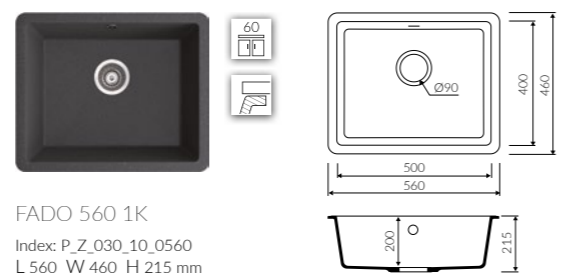
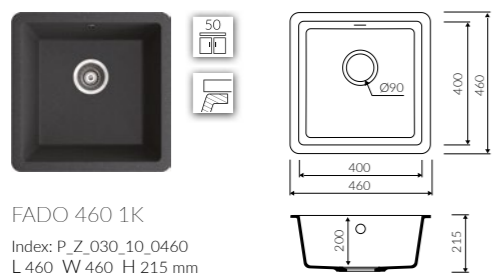
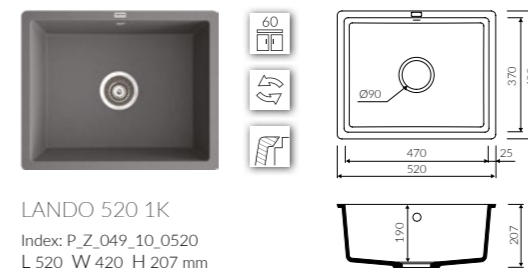
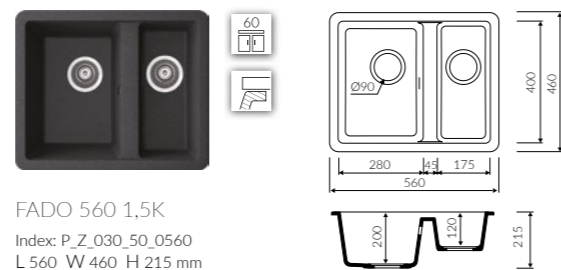
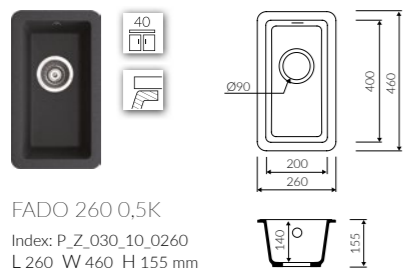

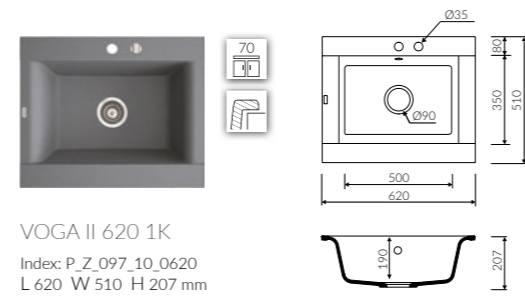

VOGA II 620 1K
Index: P_Z_097_10_0620
L 620 W 510 H 207 mm

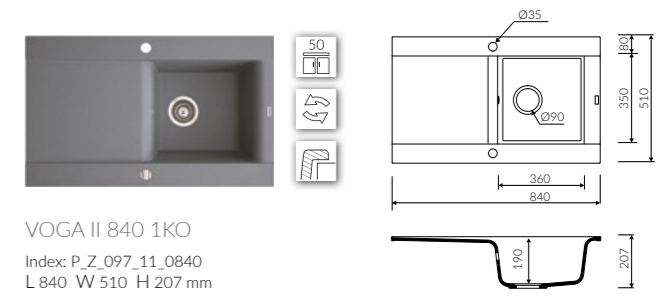

VOGA II 840 1KO
Index: P_Z_097_11_0840
L 840 W 510 H 207 mm

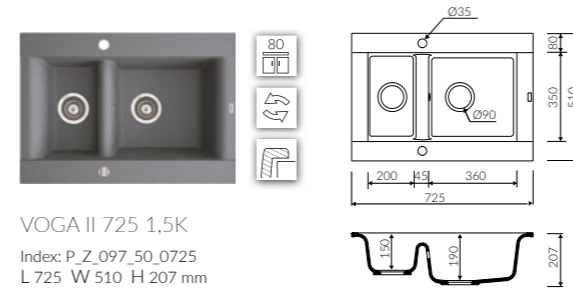

VOGA II 725 1,5K
Index: P_Z_097_50_0725
L 725 W 510 H 207 mm

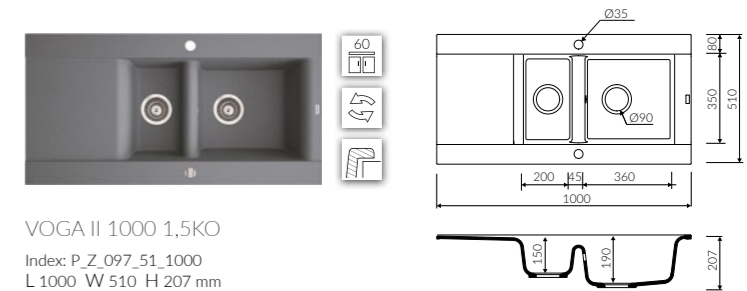

VOGA II 1000 1,5KO
Index: P_Z_097_51_1000
L 1000 W 510 H 207 mm

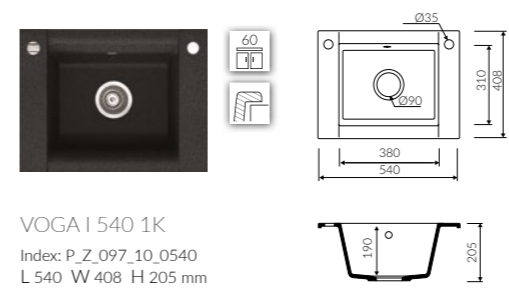

VOGA I 540 1K
Index: P_Z_097_10_0540
L 540 W 408 H 205 mm

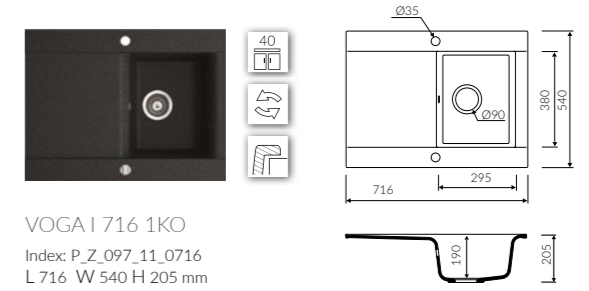

VOGA I 716 1KO
Index: P_Z_097_11_0716
L 716 W 540 H 205 mm

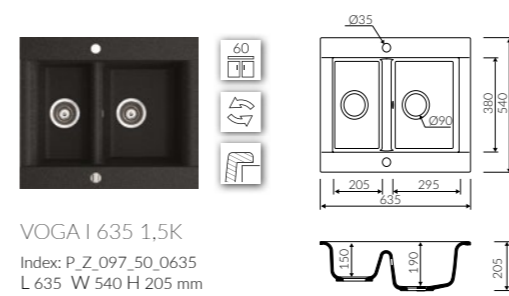

VOGA I 635 1,5K
Index: P_Z_097_50_0635
L 635 W 540 H 205 mm

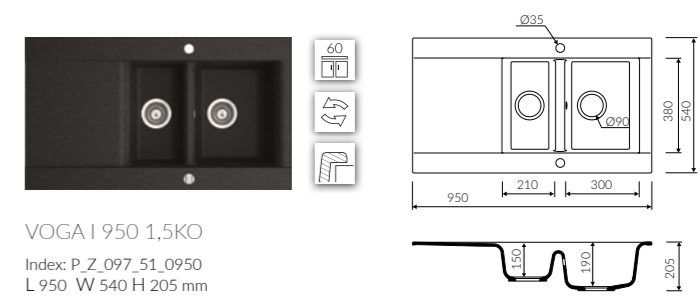

VOGA I 950 1,5KO
Index: P_Z_097_51_0950
L 950 W 540 H 205 mm

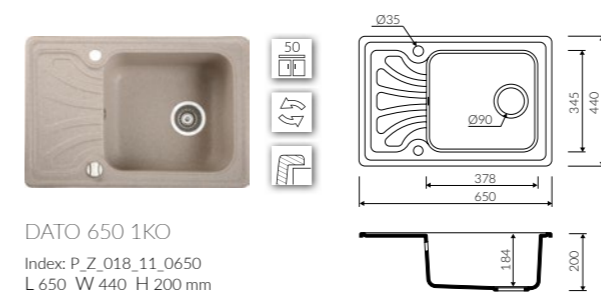
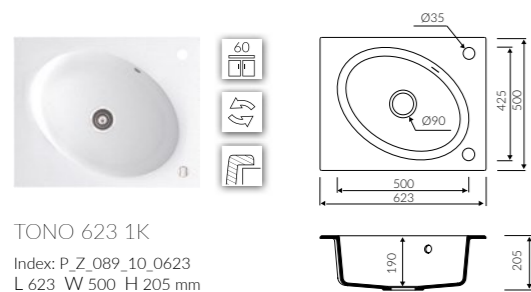

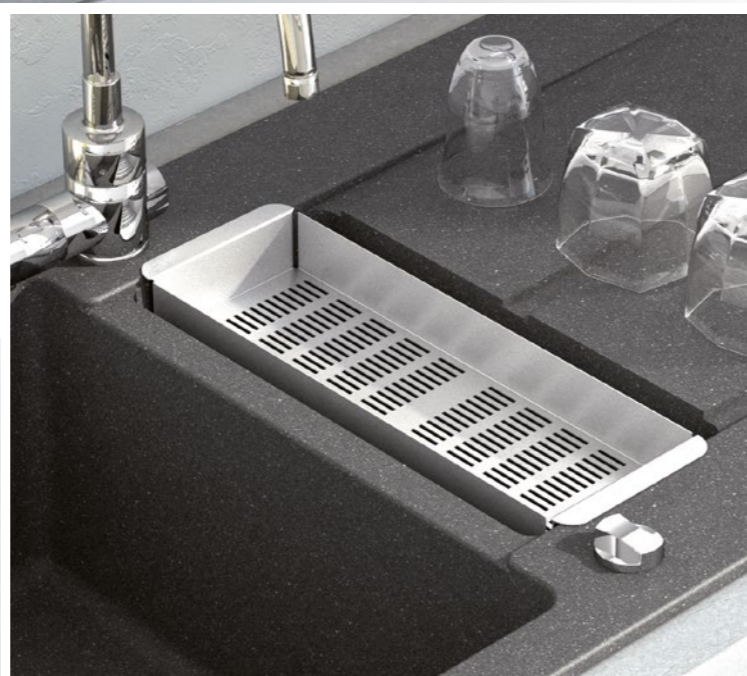
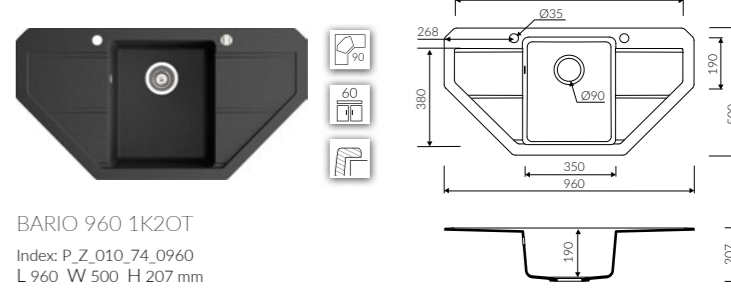
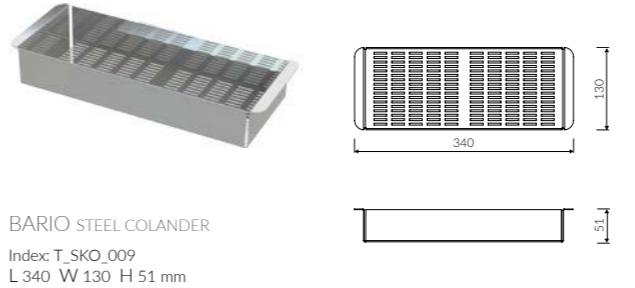
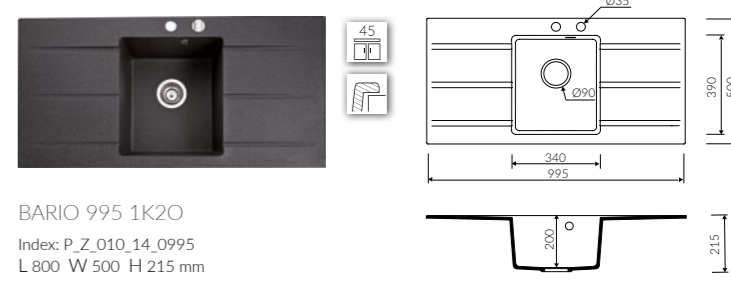
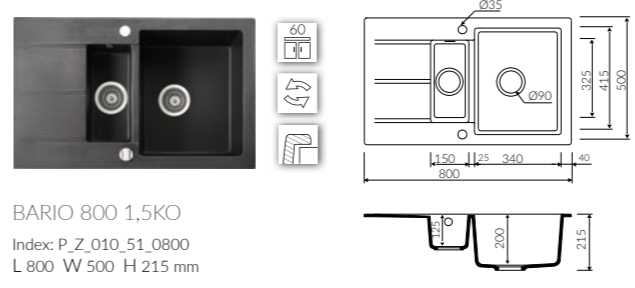
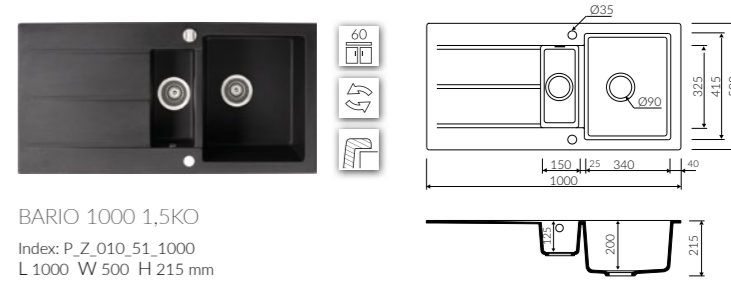
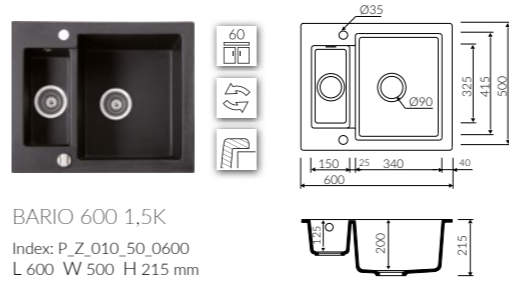
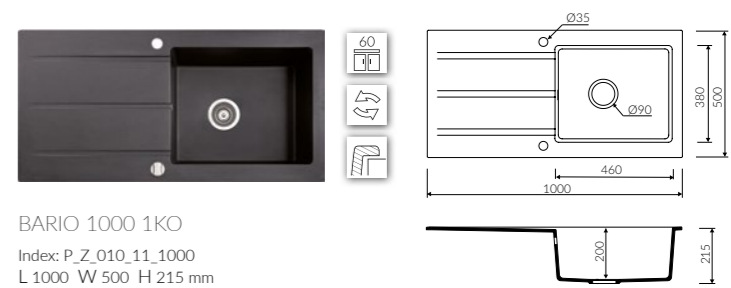
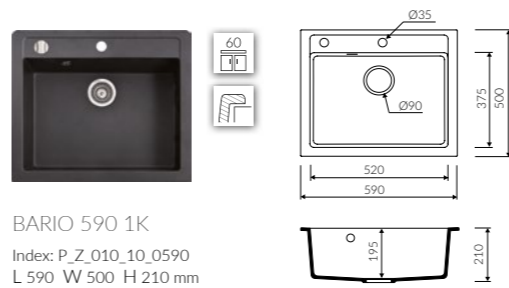



DURO 520 1K
 Index: P_Z_025_80_0520
 L 520 W 520 H 193 mm

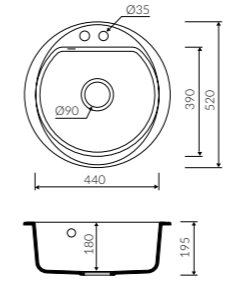

DURO 940 1K2OT
 Index: P_Z_025_74_0940
 L 940 W 470 H 193 mm

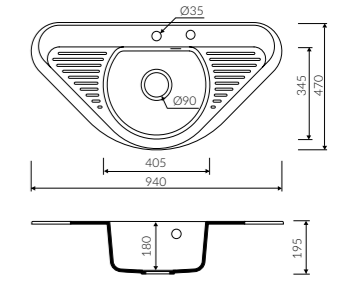

DURO 620 1KO
 Index: P_Z_025_11_0620
 L 620 W 470 H 195 mm

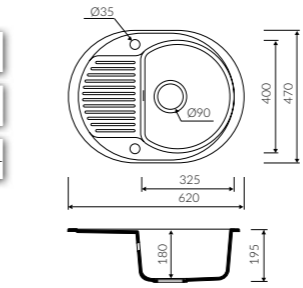

DURO 770 1KO
 Index: P_Z_025_11_0770
 L 770 W 470 H 195 mm

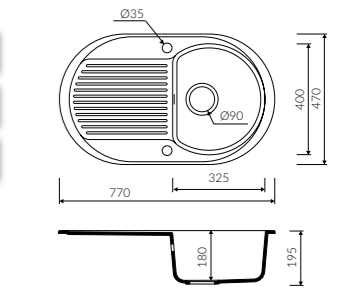

DURO 770 1,5KO
 Index: P_Z_025_51_0770
 L 770 W 470 H 195 mm

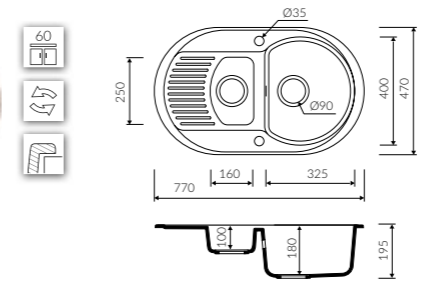

DURO 770 2K
 Index: P_Z_025_20_0770
 L 770 W 470 H 195 mm

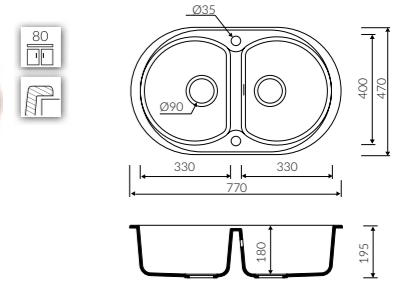

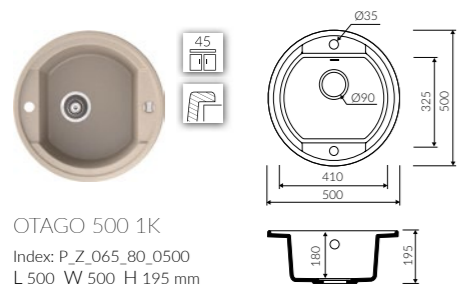

OTAGO 500 1K
Index: P_Z_065_80_0500
L 500 W 500 H 195 mm

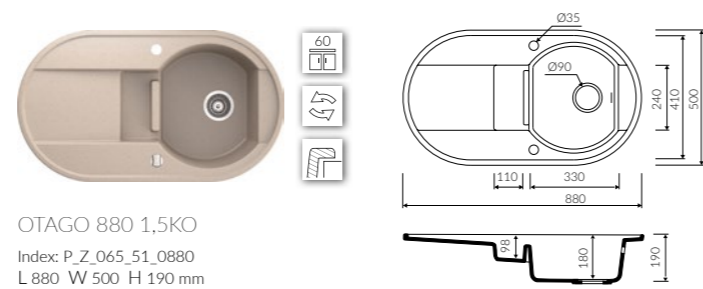

OTAGO 880 1,5KO
Index: P_Z_065_51_0880
L 880 W 500 H 190 mm

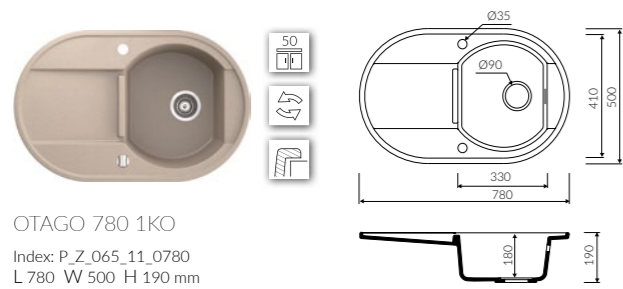

OTAGO 780 1KO
Index: P_Z_065_11_0780
L 780 W 500 H 190 mm

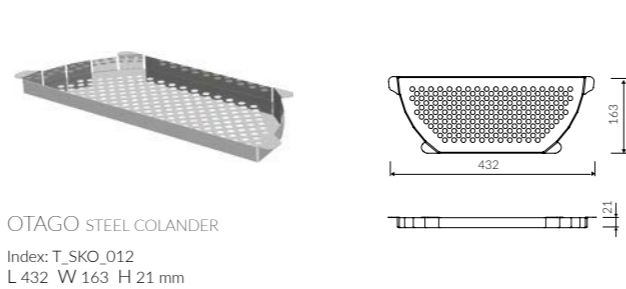

OTAGO STEEL COLANDER
Index: T_SKO_012
L 432 W 163 H 21 mm

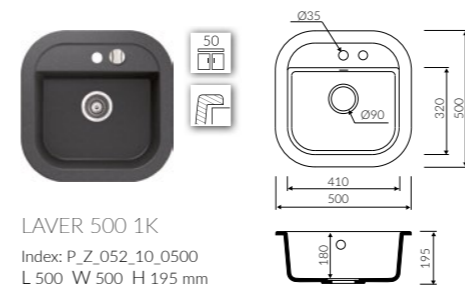

LAVER 500 1K
Index: P_Z_052_10_0500
L 500 W 500 H 195 mm

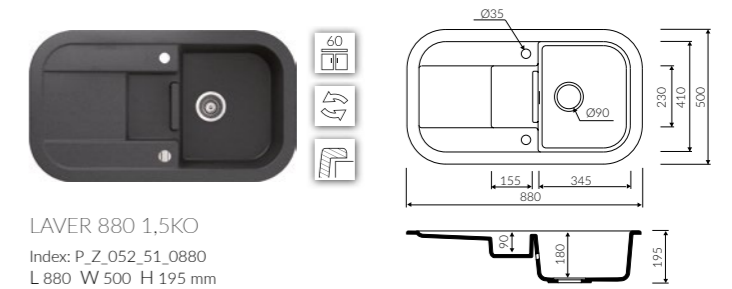

LAVER 880 1,5KO
Index: P_Z_052_51_0880
L 880 W 500 H 195 mm

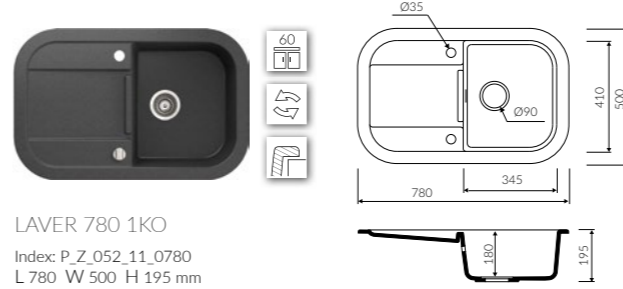

LAVER 780 1KO
Index: P_Z_052_11_0780
L 780 W 500 H 195 mm

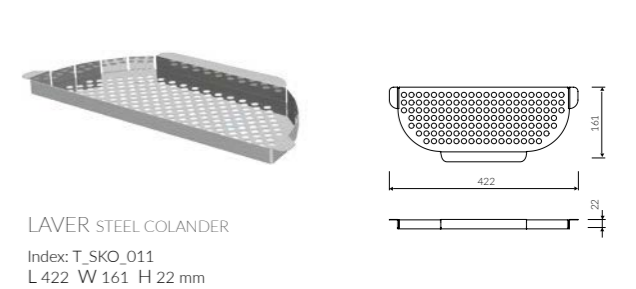

LAVER STEEL COLANDER
Index: T_SKO_011
L 422 W 161 H 22 mm

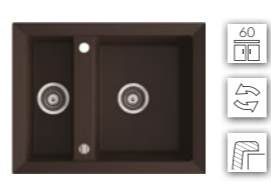

CIRE 630 1.5K
 Index: P_Z_016_50_0630
 L 630 W 500 H 195 mm

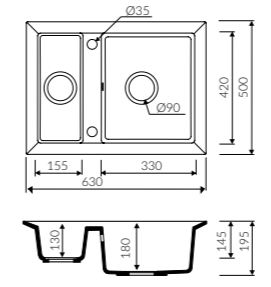

CIRE 1000 2KO
 Index: P_Z_016_21_1000
 L 1000 W 500 H 195 mm



CIRE 870 2K
 Index: P_Z_016_20_0870
 L 870 W 500 H 195 mm

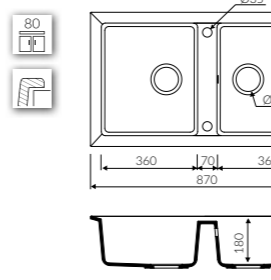

CIRE 940 1.5KO
 Index: P_Z_016_51_0940
 L 940 W 500 H 195 mm



CIRE 860 1KO
 Index: P_Z_016_11_0860
 L 860 W 500 H 195 mm

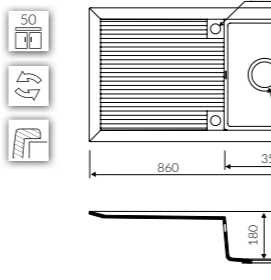

CIRE 1000 1.5KOT
 Index: P_Z_016_61_1000
 L 1000 W 500 H 195 mm

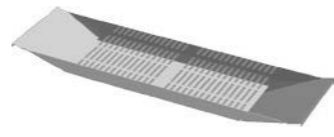
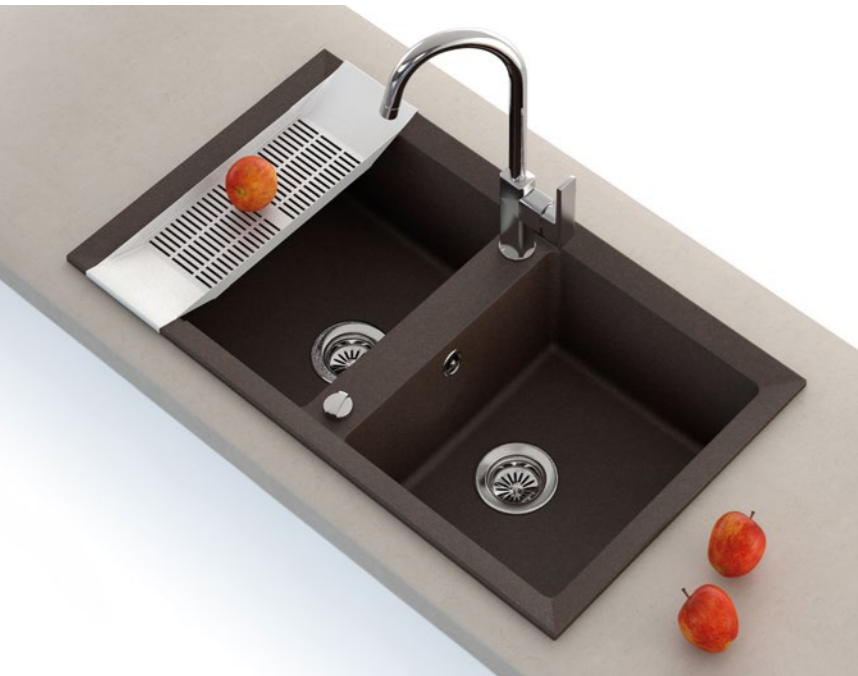

CIRE STEEL COLANDER
 Index: T_SKO_010
 L 462 W 143 H 21 mm

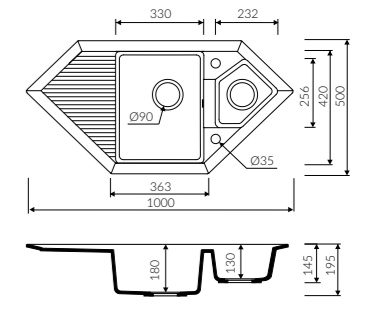
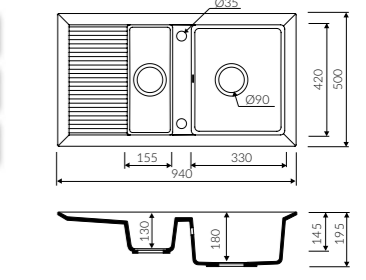
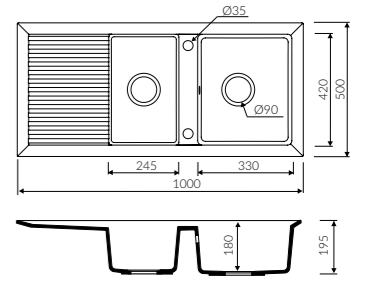
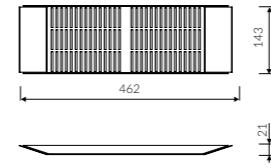

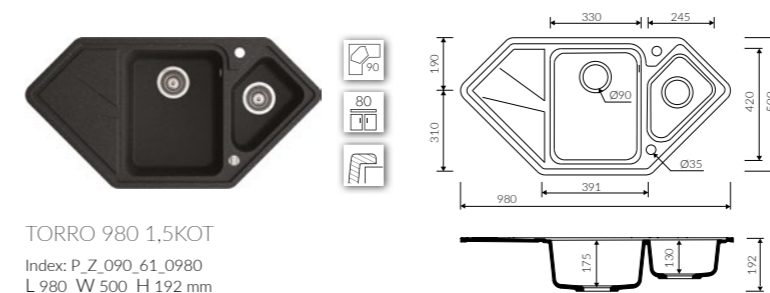
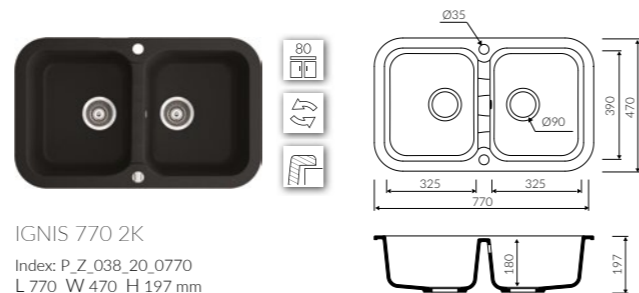
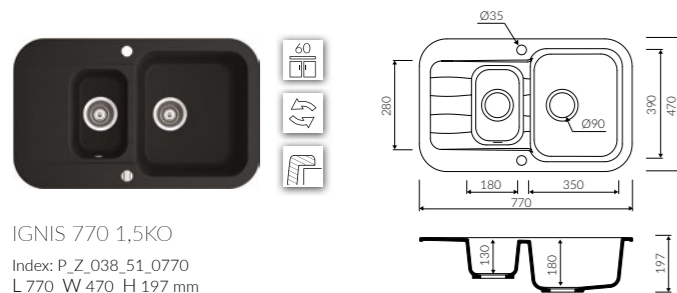
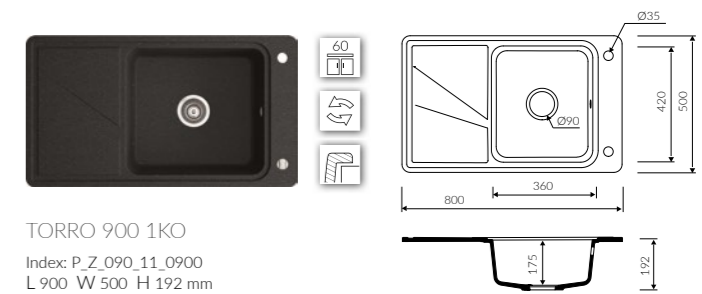
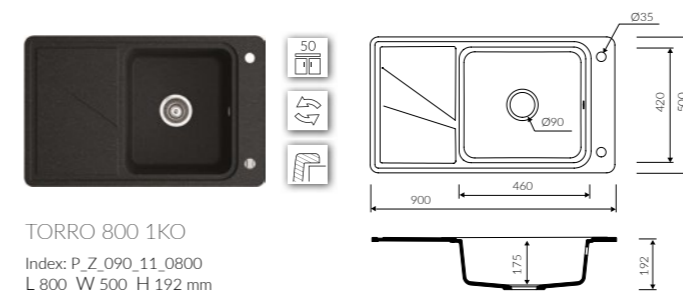
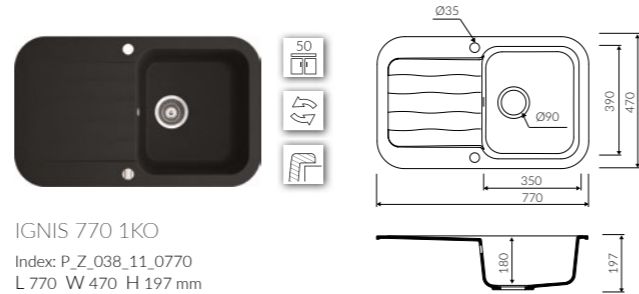
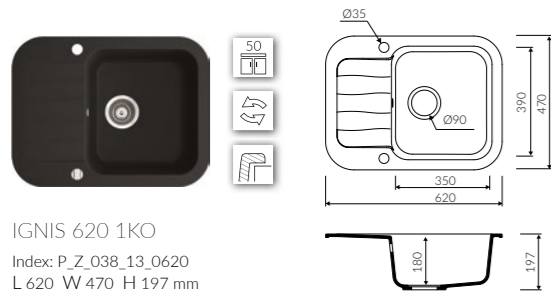

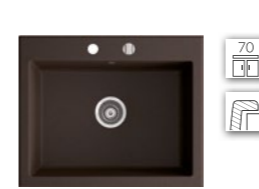

DEBRA 620 1K
 Index: P_Z_019_10_0620
 L 620 W 510 H 207 mm

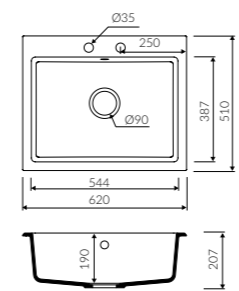

DEBRA 1000 1.5KOT
 Index: 436 613 0xx
 L 1000 W 510 H 207 mm

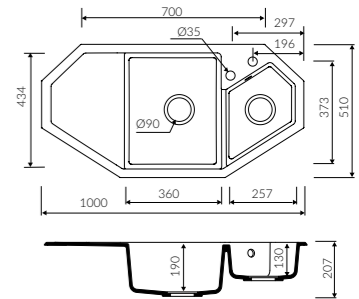

DEBRA 800 2K
 Index: 436 203 0xx
 L 800 W 510 H 207 mm

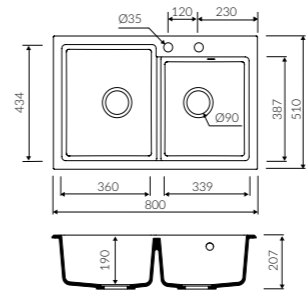

DEBRA 840 1KO
 Index: 436 113 0xx
 L 840 W 510 H 207 mm

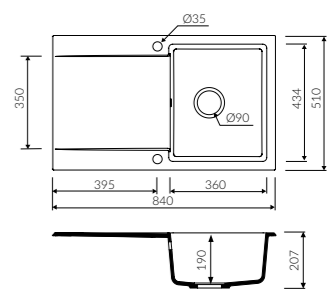

DEBRA 1000 1.5KO
 Index: 436 513 0xx
 L 1000 W 510 H 207 mm

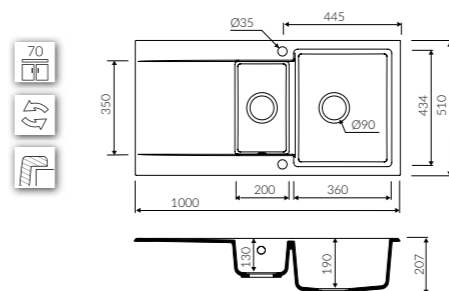

DEBRA 930 2KON
 Index: 436 213 0xx
 L 830 W 830 H 217 mm

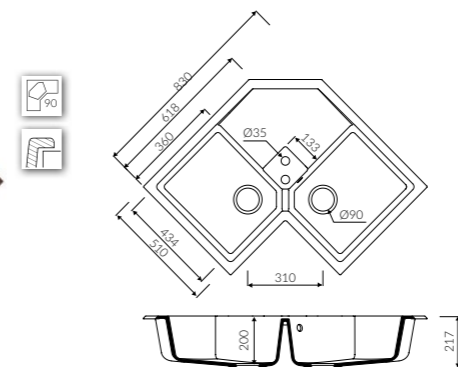

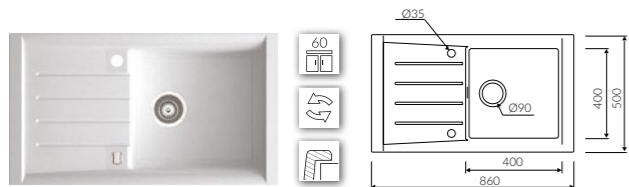

PROFIR 860 1KO
 Index: 160 113 0xx
 L 860 W 500 H 230 mm

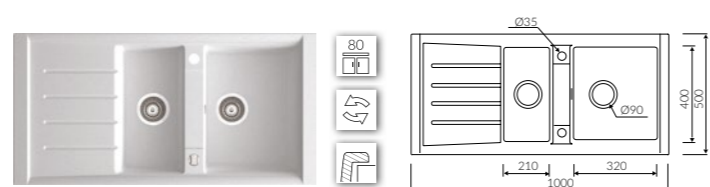

PROFIR 1000 1,5KO
 Index: 160 513 0xx
 L 1000 W 500 H 230 mm

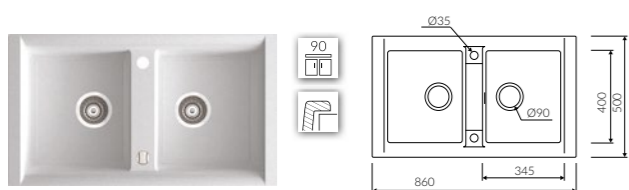

PROFIR 860 2K
 Index: 160 203 0xx
 L 860 W 500 H 230 mm



PROFIR 1160 2KO
 Index: 160 213 0xx
 L 1160 W 500 H 230 mm

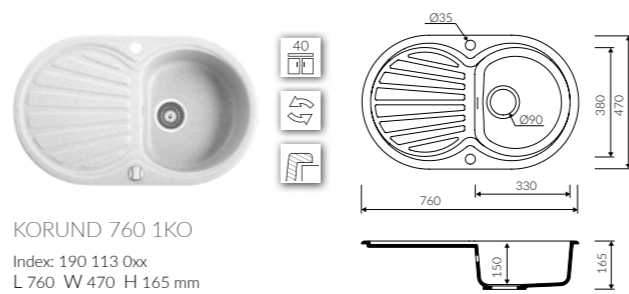

KORUND 760 1KO
 Index: 190 113 0xx
 L 760 W 470 H 165 mm

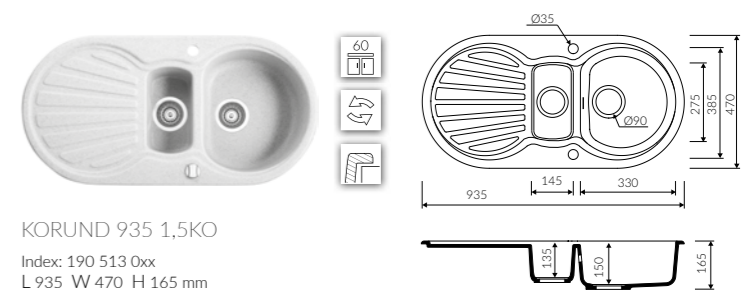

KORUND 935 1,5KO
 Index: 190 513 0xx
 L 935 W 470 H 165 mm



DIMENSION TOLERANCES

KITCHEN SINKS

length: (+3/-3)
width: (+2/-2)
height: (+3/-3)

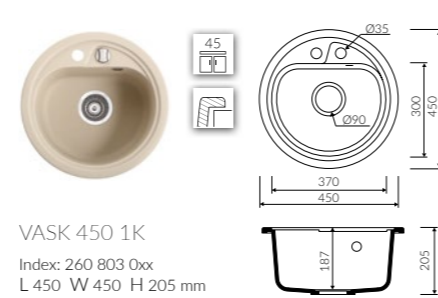
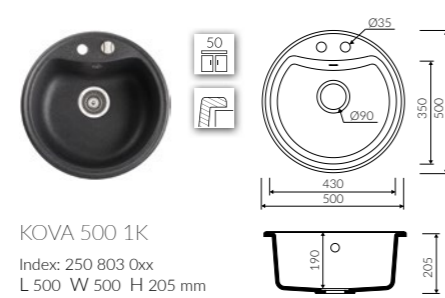

DECORATIVE KITCHEN SINK STRAINERS



Available for models TESSA, BATEA, IVO, OPAL with no extra charge. For other models strainers are available upon extra payment.



Available for models LANDO, OLWIN, COMBO, VOGA II with no extra charge. For other models strainers are available upon extra payment.

marmorin